



📍 Géomètres-Experts Foncier ■
56, Rue Saint-Laurent - C.S.20786 - 77400 LAGNY SUR MARNE
TEL 01.64.30.02.69 - E-mail: accueil@cabinetmarmagne.fr



DEPARTEMENT DE LA SEINE-ET-MARNE
COMMUNE DE COULOMMIERS







Place de l'Ile de France
Avenue Robert Elvert
Rue du 19 Mars 1962

Cadastre : Section BR n°138p

PLANS DE COPROPRIETE

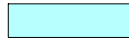
Résidence " Terrasses de Vaux "

LEGENDE :

-  Lot Privatif
-  Lot Privatif
-  Lot Privatif
-  Lot Privatif
-  Lot Privatif
-  Lot Privatif
-  Parties Communes

DATE : 18 Octobre 2022
Dossier N° 22739



BR-109
 (Superficie cadastrale : 637 m²)

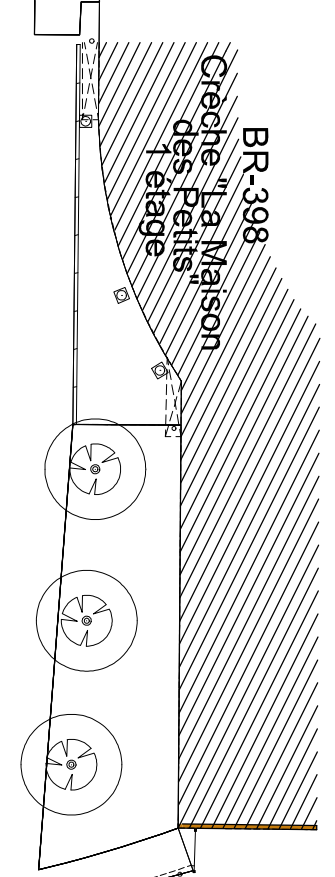
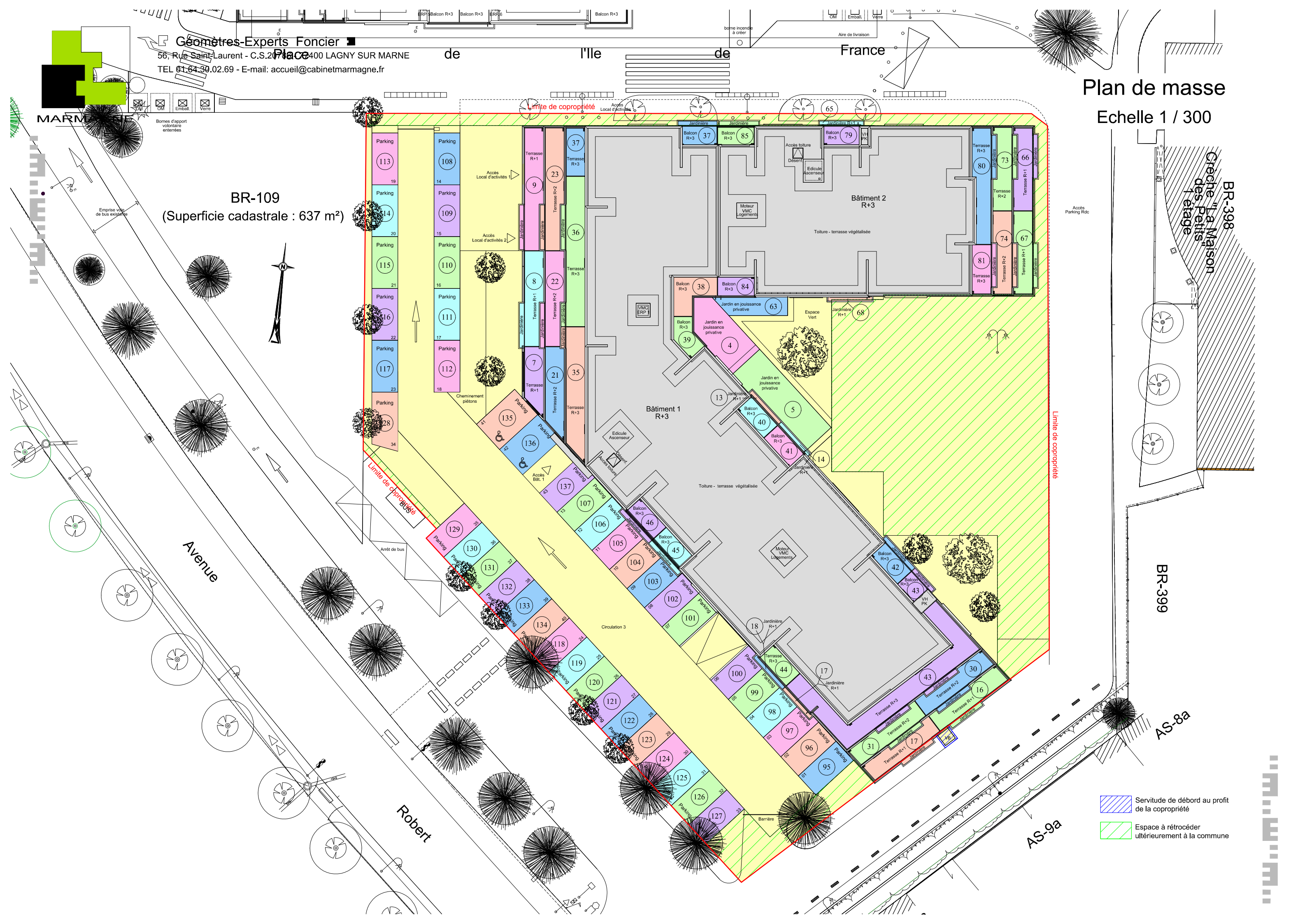

- Servitude de débord au profit de la copropriété
- Espace à rétrocéder ultérieurement à la commune



Bâtiments 1 et 2
Rez-de-chaussée

Echelle 1 / 300

BR-109
 (Superficie cadastrale : 637 m²)

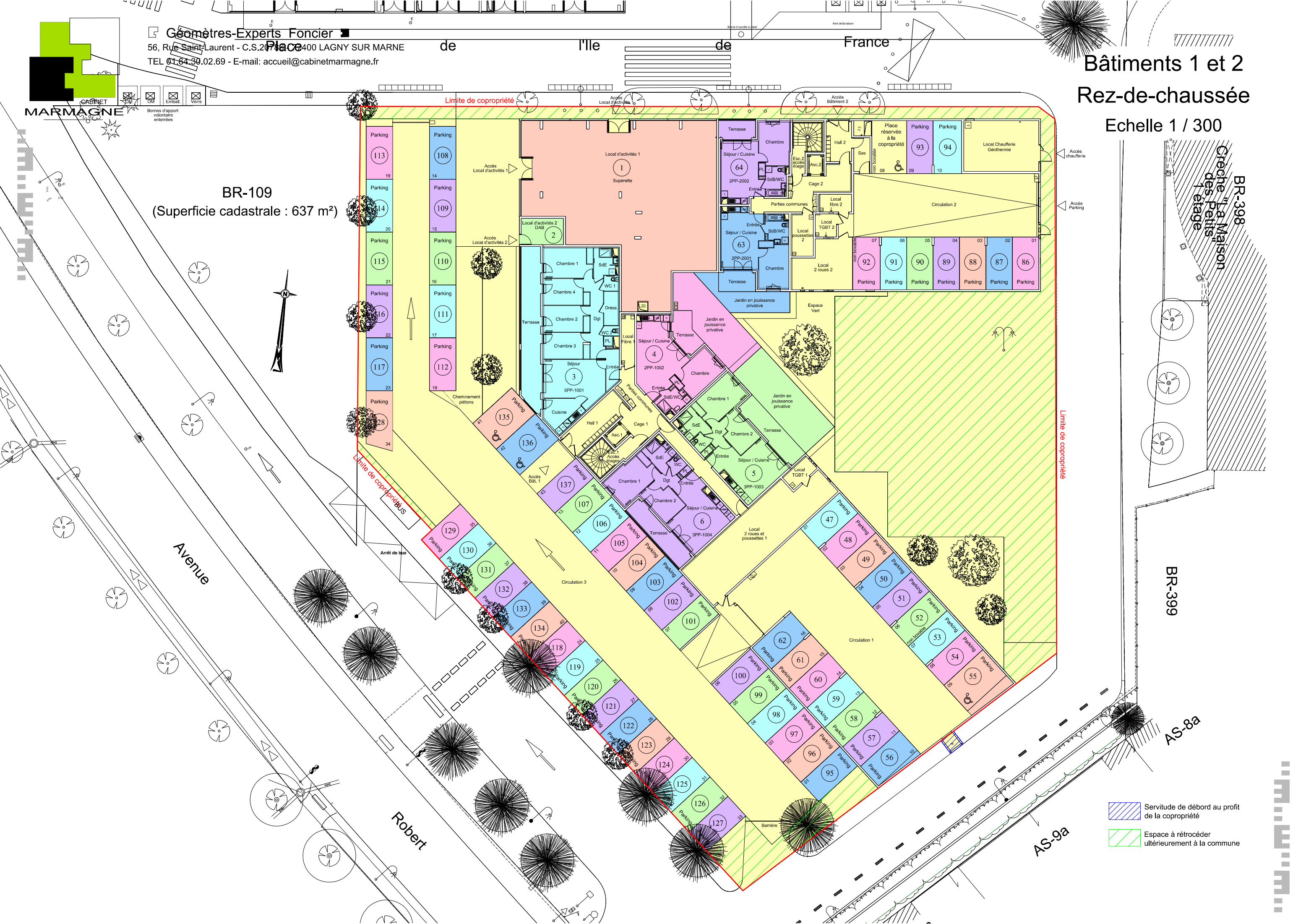

- Servitude de débord au profit de la copropriété
- Espace à rétrocéder ultérieurement à la commune



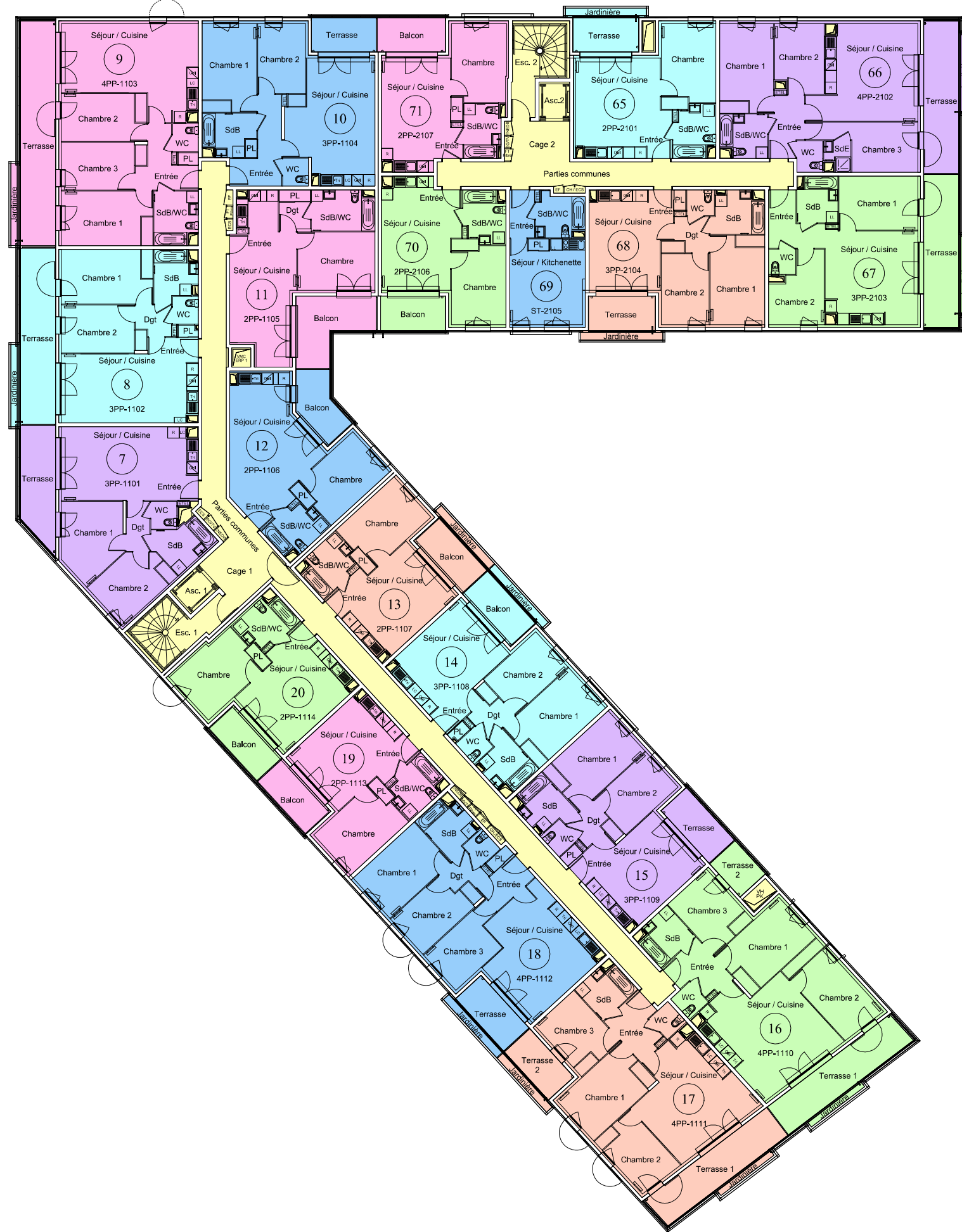

Bâtiments 1 et 2
2ème étage
 Echelle 1 / 250

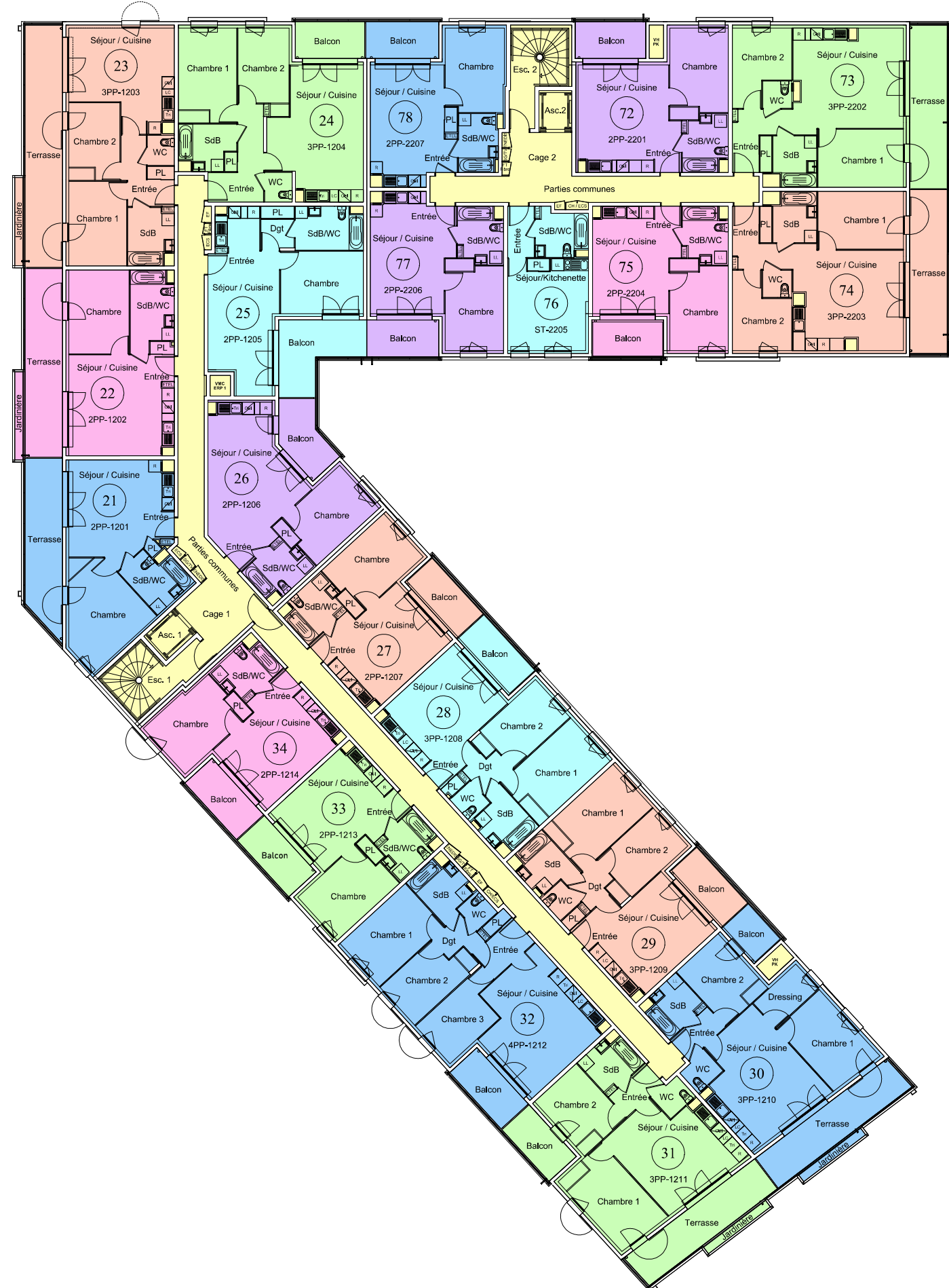

Bâtiments 1 et 2
3ème étage
 Echelle 1 / 250

