

Extra nuts to be used with original bolts that mount the original exhaust hanger bracket. This will allow you to remove the original hanger bracket but re-use the bolts as to not leave empty holes once the bracket is removed.

Knurled collar nut M6
Cod.200322

LV-10 silencer RHS
Stainless steel
Cod.3015201481

Knurled collar nut M8
Cod.200298

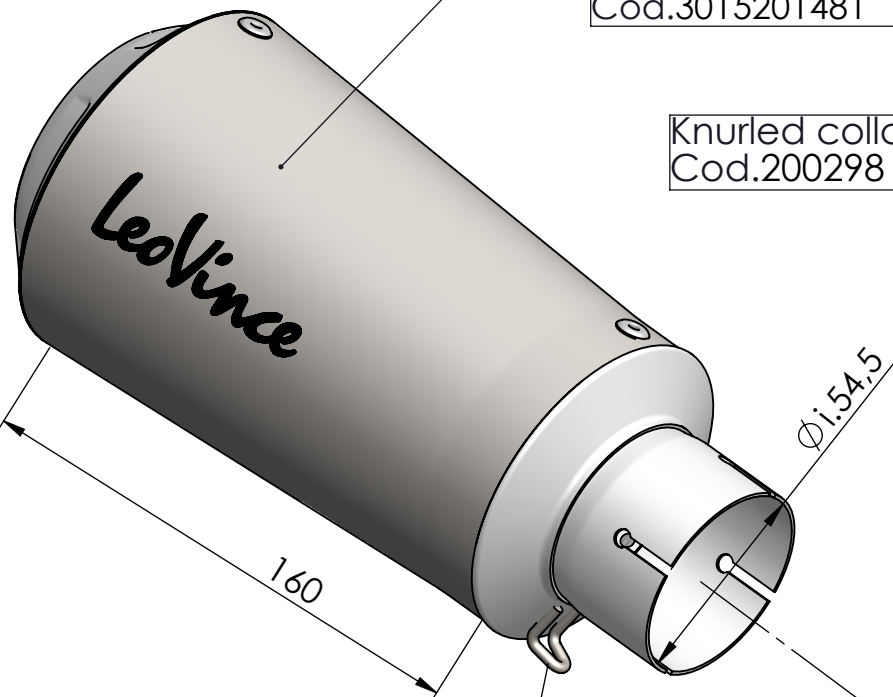

Strap-in Ø57
Stainless Steel
Cod.300057530

Short helical spring
tensile
Cod.303949001

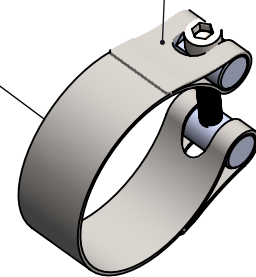

Stainless Steel
Bracket
Cod.3015201501

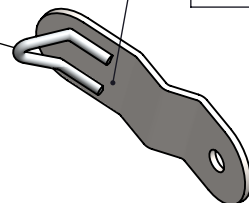

ART. 15201

YAMAHA YZF-R1 / M

SLIP-ON - LV-10 - STAINLESS STEEL